



# M85

1/1 New Generation Airsoft Electric Gun  
Use 6mm BB Bellet

Variable Hop Up System  
Adjustable Rear Sight

Semi/Full Automatic

可调Hop Up系统

可调式后准星

单发/连发功能

Can be Equipped with Adjustable Laser Aim  
Module and Adjustable Electronic Gun Sight  
可配备可调电子瞄准镜、可调激光瞄准器。



M85



M85P

Parts added \* symbol are suitable for specific packing only.

注：有带\*之配置只用于特定包装

Always read through this manual before operation. Remain this manual  
for future reference.

使用前请先阅读说明书，保存此说明书以供日后使用参照。

Age : above 18

USER MANUAL



# WARNING 注意

Always read through this manual before operation

使用前请阅读此说明书

① Under mount rail

下导轨

② Hand guard

前护木

③ Handguard button

护木按钮

④ Magazine catch lever

弹匣锁钮杆

⑤ Selector

功能杆

⑥ Grip

把手

⑦ Stock lock button

枪托锁按钮

⑧ Long mount rail

上导轨

⑨ Folding stock

折叠枪托

⑩ Rear sight

后瞄准星

⑪ Front sight

前瞄准星

⑫ Flash hider

枪头

⑬ Side mount rail

侧导轨

⑭ Variable Hop Up Adjustment Knob

可调Hop up调节钮

⑮ Magazine

弹匣

⑯ Trigger

扳机

⑰ Stock lock rib

枪托扣只

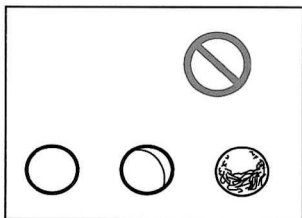
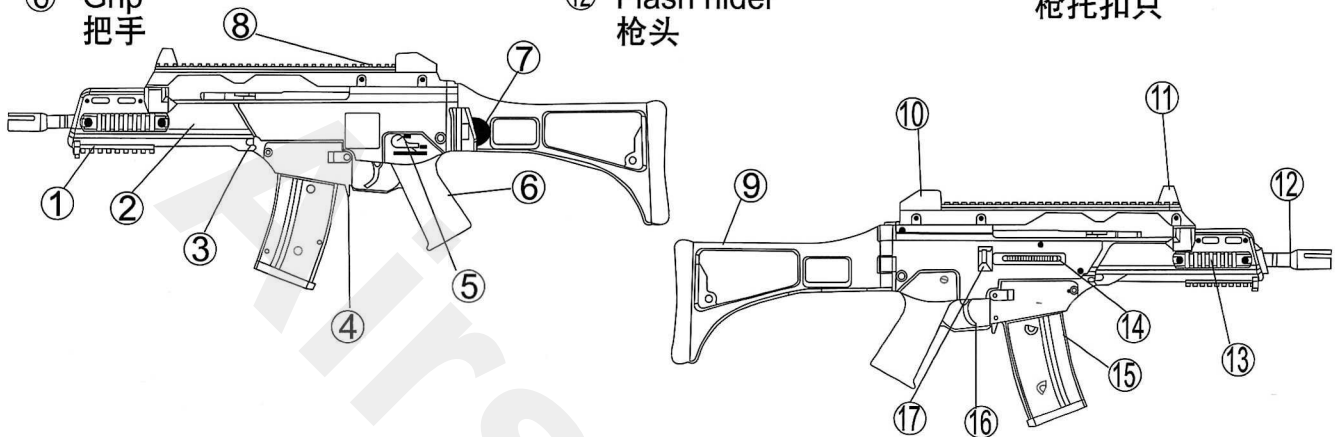

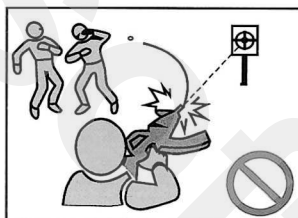

- Always use precision BB Bullets for this air gun. Never use any used BB bullets.  
请使用精密BB子弹。不要使用任何使用过的BB子弹。

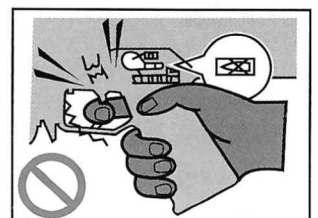

- Never hold the gun sideways as the BB bullets will curve right or left. This is due to the HOP-UP system. 切勿把枪支侧置射击，因为上翻弹(HOP UP)功能会导致弹道偏向左侧或右侧



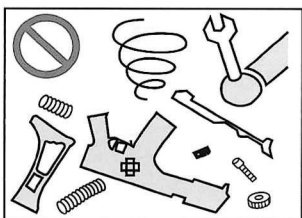

- Pulling the trigger with the Safety lever being set to  may damage the gun. 当选择杆拨在  档时，切勿用力扳动扳机。



- Don't disassemble beyond what is necessary. Or the gun may be damaged. 不要随意拆解，枪可能被损伤。



- Never aim or shoot a person or animal as the target. Always set the selector on  position except when you are ready to shoot a target. 不可把人或动物当作目标瞄准或射击。请把选择杆拨在  档，除非准备射击一个明确的目标。

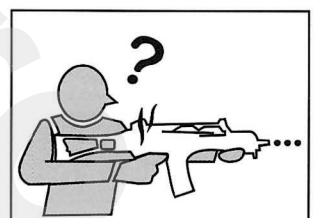

- Smell may be generated from the motor for a while when a new air gun is operated, this is the normal operation of the gun. 刚使用新枪时，马达运转一阵后可能会产生气味



- Do not look directly into the gun barrel to avoid accidental discharge of BB. 不要直接地看枪管，避免BB弹意外发射。

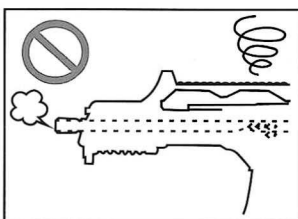

- When bullets are clogged, immediately stop operation. Remove clogged bullets and then restart operation of the air gun. 当塞弹时，立刻停止操作。清除阻塞子弹，然后重新开始操作气枪。

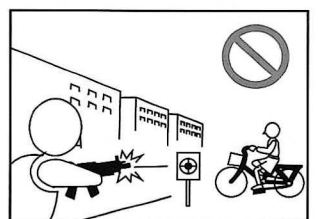

- Select a safe place for operating the air gun, avoiding places where people and cars pass cross or third persons are around. 选择一个安全的地方操作气枪，避免在有人和汽车的路上操作气枪。

# 1.parts 配件

7.2V Rechargeable battery

7.2V充电电池

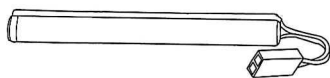

Special charger

专用充电器



Handle

握把

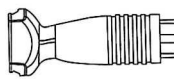

Adjustable Laser Aim Module\*

可调激光瞄准器\*

可调激光瞄准器\*



Bullet Loader

装弹器

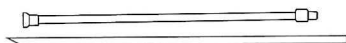

Flashlight\*

照明手电筒\*



Adjustable Electronic

Gunsight

可调电子瞄准镜



Shooting Glasses

防弹眼镜



Silencer\*

消声器\*



Sling

背带



# 2. Install & replace battery 安装及更换电池

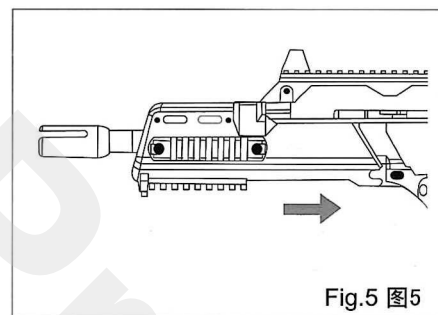
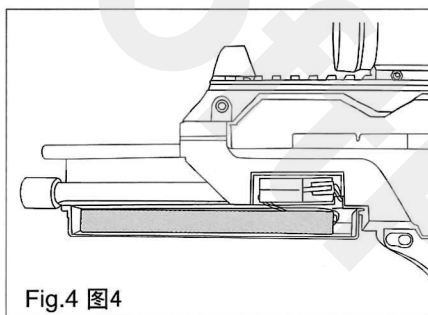
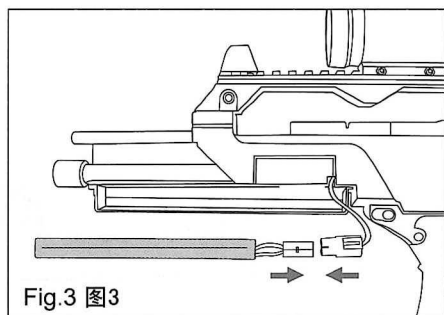
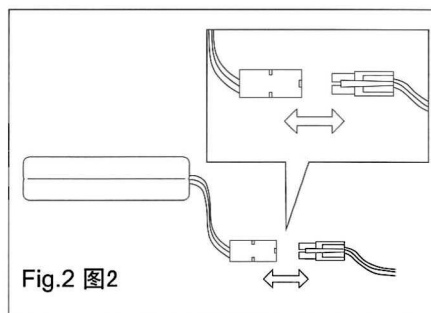
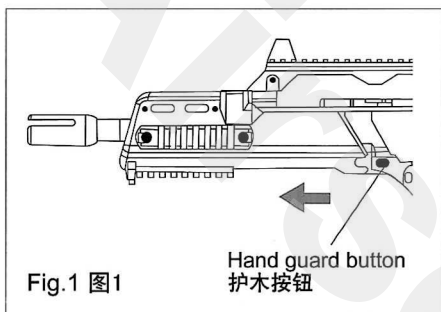

- Remove all accessories installed on the Handguard by reversing the installation instruction as previously stated  
卸去装在扶手处的所有附件
- Press and hold the Rail Panel Release while sliding the Rail Cover forward Completely disengage the Rail Panel from the handguard.(Fig.1)  
按住护木卸钮,同时向前完全滑出.(图1、)

- Install the battery into the Battery Chamber. Plug the battery connector into the wire socket. (Fig.2, Fig.3, Fig.4)  
装入电池,把电池接头放置在线槽内.(图2,图3,图4)
- Close the Battery Compartment and push the Handguard Locking Ring into position(Fig.5)  
前护木套入前扶把直到扣上锁钮.(图5)

# 3. Install Quick Aim Electronic Sight\* 安装电子瞄准镜\*

No:GS11

Adjustable red cross

QUICK AIM ELECTRONIC (QAE) SCOPE\*

(只限于特定包装 For specific packing)

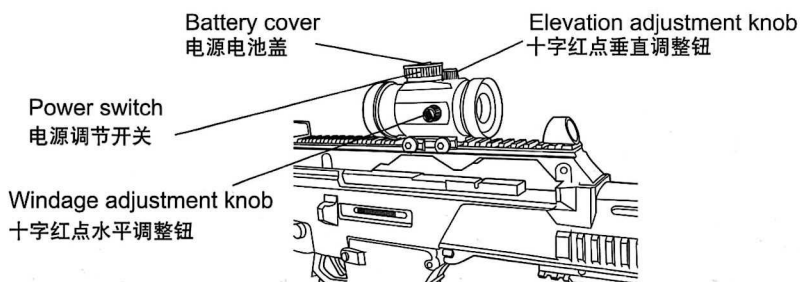

## POWER 电池安装

- Your QAE Scope GS11 is powered by one 3 volt lithium long life battery No.CR2025 or equivalent. Should the red dot become dim or does not light at all, you will need to replace the battery. To install new battery, unscrew the battery cover in anticlockwise, and recover it in clockwise after replace the old battery with new one.

百中瞄准镜GS11已安装有一节3伏长寿锂电池(GR2025,或其替代品),如果红点变暗或根本不发光,则须更换电池。更换电池时,先按逆时针方向旋开电池盖,取出旧电池,换入新电池,盖上电池盖并按顺时针方向旋紧。

## MOUNTING 装上瞄准镜

- When you mount this sight on a dovetail base gun, unscrew right mounting screws, slide the sight onto the dovetail and tighten it at proper position.

安装该镜时,先拧松右边的固定螺丝,把瞄准镜基座卡入楔形槽,调节至适当位置并旋紧螺丝。

## OPEN & CLOSE POWER 打开及关闭电源

- Engage the sight by turning the ON/OFF switch. Turning the switch at 2 position will open the sight with hiht light (suit for day), Turning the switch at 1 position will open the sight with dark (suit for night), Turning the switch at 0 position will close the power.

把开关调节钮旋至"2"位置,打开电源,红点较亮(适合白天使用),把开关旋钮旋至"1"位置,红点较暗(适合晚上使用),把开关旋钮旋至"0",关闭电源。

## ADJUST THE RED CROSS SIGHT 调节红色十字准星

- Adjust the sight vertically by turning the elevation adjusting knob

旋转垂直调节钮,以从垂直方向调准瞄准镜内之十字准星

Turning cross shifts down the shooting point

Turning counter clockwise shifts the sight up th shooting point

顺时针方向为往下调节十字准星

逆时针方向往上调节十字准星

- Adjust the sight horizontally by turning the wintage adjusting knob

旋转水平调节钮,以从水平方向调准瞄准镜内之十字准星

Turning cross shifts the sight to the right.

Turning counter clockwise shifts in to the left.

顺时针方向为往左调节十字准星

逆时针方向为往右调节十字准星

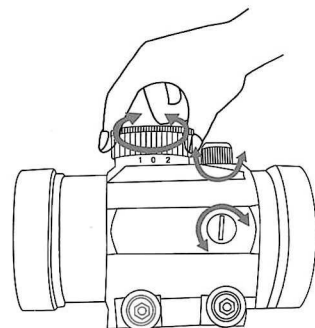
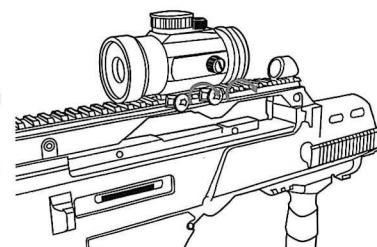
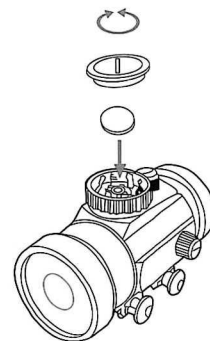

## 4. Install Adjustable Laser Aim Module and Flashlight\* 安装激光瞄准器及手电筒\*

### Adjustable Laser Aim Module Operation 可调激光瞄准器调节操作(只限定特定包装)

- Install the ALAM on the appropriate position, make two adjustment holes outside  
把可调式激光瞄准器安装在枪上导轨之适当位置,把瞄准器头部二调节孔置于外面。

- Adjust the sight by turning the adjusting screw using the 2.5mm hexagonal key for the M5 setscrew.  
Turning clockwise shifts up and left the shooting point. Turning counter clockwise shifts the sight down and right the shooting point.  
把六角扳手插入瞄准器调节孔,按往顺时针方向旋转,射出红点时向左、上方向移动。反之则向右、下方向移动,二小孔可同时调节,以达到更准确效果。

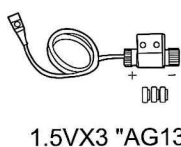

1.5VX3 "AG13"

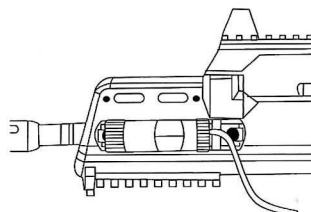
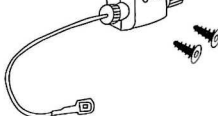
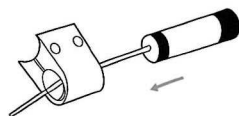

Direction adjustment knob  
方向调节钮

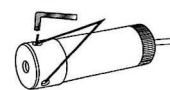

### Flashlight Operation 手电筒操作

- Slide the flashlight onto the handguard rail, adjust for a best position. Press the power button.  
把手电筒从护板导轨前端套入,调整至适当位置。  
旋紧固定螺丝。  
按下电源开关。

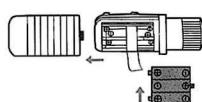

Flashlight ON/OFF  
手电筒开关

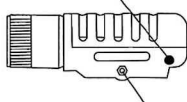

Flashlight lock knob  
手电筒锁钮

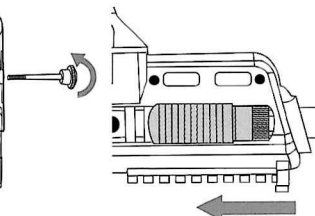
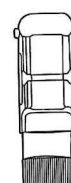

## 5. Setting the magazine 装入子弹

1. Press the magazine Catch Lever to remove the magazine  
按弹匣卸钮，取出子弹匣。

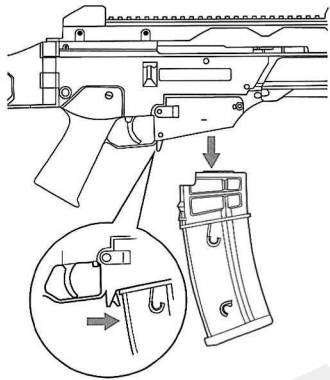

2. Load the Bullets into the loader.  
(It can be loaded with about 30 bullets.)  
将子弹装入装弹器内。(约30颗)

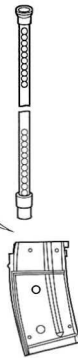
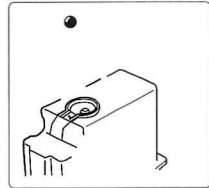

3. Push the bullets down using the Bullets Loading Rod. Do not pull over, otherwise it will damage the magazine.  
用装弹棒将装弹器内的子弹推入弹匣内。注意不要过度用力。

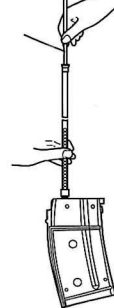

Warning! Always use precision ground 6mm BB bullets for accuracy and safety. Never re-use bullets.  
警告! 务必使用优质BB弹以确保安全及准确度。

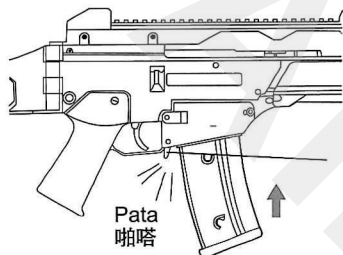

Magazine release button  
弹匣卸钮

Pata  
啪嗒

4. Insert the loaded magazine into the rifle.  
把弹匣插入枪支。  
To remove the magazine, press the magazine Catch Lever to disengage the magazine.  
移去弹匣时，先按住弹匣卸钮，卸开弹匣。

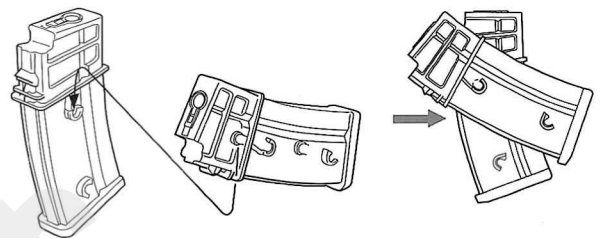

### ● Removing clogged bullets 卡弹处理

- (1). Remove the magazine and return the hop up adjustment to the Normal position.  
如发生卡弹时，先卸下弹匣，将上翻弹(Hop up)功能钮调至正常位置。
- (2). Insert the cleaning rod from the load edge of the barrel, be careful so that the angled part of the cleaning rod faces down, and remove clogged bullets.  
把清弹棒插入枪管，(清弹器斜面向下)。子弹从弹匣插口退出。

Fig.1  
图1

Fig.2  
图2

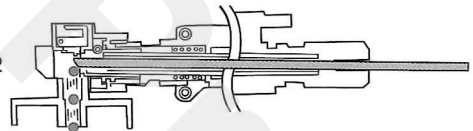



## 6. Firing (confirm complete safety of environment before firing.) 发射(发射前请务必确认环境是否安全)

Activating the trigger carelessly is extremely dangerous. Put your finger on the trigger unless you are ready to shoot at a target.

小心走火，除非你已准备射击，否则不要把手指放在扳机处。

### 1. Semi auto shooting 半自动射击

- set fire/safety lever to 处。  
把发射/保险拔杆拔至 处。
- Aim the rifle at your target.  
架好枪支，瞄准目标。
- Pull the trigger.  
拨动扳机发射。

### 2. Full auto shooting 全自动射击

- Set fire/safety lever to 处，其他步骤跟半自动相同。

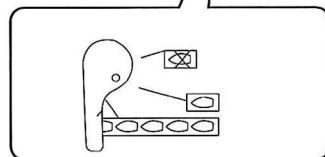
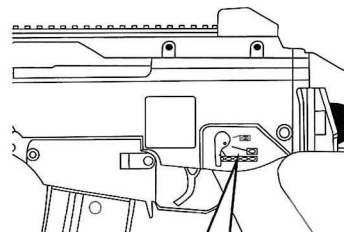

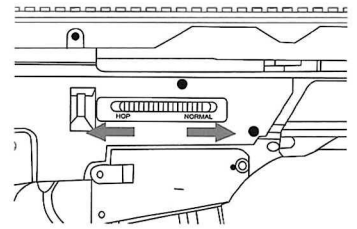

3. Adjust variable Hop-up system for best shooting  
 调节可调式HOP-UP系统以达到最佳射击效果
- Slightly slide the hop-up adjustment knob.  
 轻轻滑动HOP-UP调节钮
  - Shoot a few bullets, exam the trajectory and make further adjustment if necessary.  
 把按钮向前滑动则射出BB弹微调向下, 把按钮向后滑动则射出BB弹微调向上.



To prolong motor lifetime and maintain the best shooting performance, do not shoot over 5 minutes continuously in the Full auto mode.  
 注意: 为延长电机使用寿命及保持最佳性能, 请不要在全自动方式连续射击超过5分钟.

## 7. Remove other parts 安装其它部件



Warning! Before you follow the assembly instruction, make sure to remove the magazine and set the Fire/Safety Lever on position   
 警告! 先卸去弹盒并把发射/保险拨杆拨至  位置, 再进行部件装配.

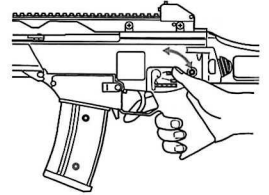

### Install Front Barrel / Silencer 安装前枪管/消声器

- Fasten the barrel into the front part of the rifle  
 按顺时针方向装上前枪管或消声器

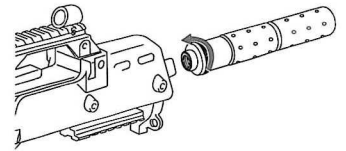
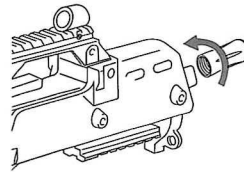

### Install Foregrip 安装前手柄

- Loosen the Locking Scdrew to make sure the Locking Column is below the surface of the base.  
 旋松锁柱, 注意其顶点低于轨道面.
- Slide Foregrip onto the rail, and adjust for the best position.  
 把前手柄套入下导轨, 滑至适当位置.
- Tighten the Locking Scedw for further stability of the Foregrip.  
 DO NOT overtighten the screw! Over tightening will be damage the Foregrip.  
 旋紧锁柱, 注意不要过度用力.

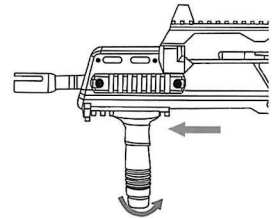

## 8. Swing Stock and Sight Operation 摆式枪托及准星调节

- Press the button of the gunstock to snap down the gunstock.  
 按枪托按钮, 可以把枪托扣到枪托扣只上.

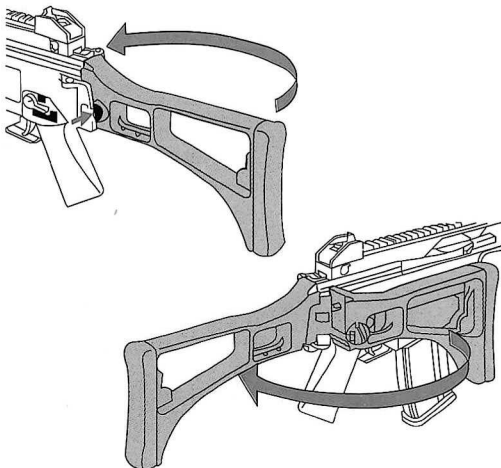

- You can adjust the rear sight using the setscrew included in the product.  
 本产品内含螺丝刀一把, 可用该螺丝刀调节后准星.

- ① Adjust the sight vertically by turning the elevation adjusting screw using the 2.5mm hexagonal key for the m5 setscrew.  
 用螺丝旋转后准星: 垂直调节钮可对后准星做上下调节.
- ② Adjust the sight horizontally by turning the wintage adjusting screw using the 2.5mm hexagonal key for the m5 setscrew.  
 用螺丝旋转后准星: 水不调节钮可对后准星做左右调节.

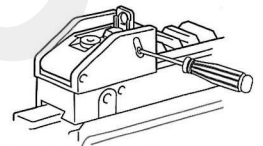
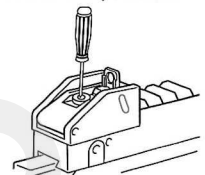

Normal shooting  
 通常射击用

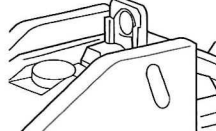

Precision shooting  
 精密射击用

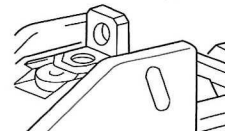

## 9. Maintenance 养护

- Keep the rifle in clean condition.  
 把枪支放置在清洁地方
- Regularly clean the barrel with soft cleaning rod.  
 定期用洁净导棍清洁枪管
- Never used dirty, damaged or distorted bullets.  
 禁止用脏污的, 受损的或劣质子弹.